

**GAMET**<sup>®</sup>



# Drawer slides and drawers

## Roller drawer slides



PR-1011

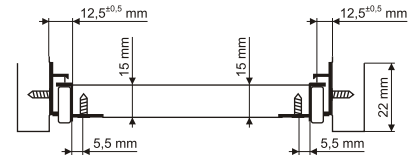

PR-1011	250			25		PR-1001	450		25
PR-1011	250	BR		25		PR-1011	450	BR	25
PR-1011	250	CZ		25		PR-1011	450	CZ	25
PR-1011	250	MET		25		PR-1011	450	MET	25
PR-1011	300			25		PR-1011	500		25
PR-1011	300	BR		25		PR-1011	500	BR	25
PR-1011	300	CZ		25		PR-1011	500	CZ	25
PR-1011	300	MET		25		PR-1011	500	MET	25
PR-1011	350			25		PR-1011	550		25
PR-1011	350	BR		25		PR-1011	550	BR	25
PR-1011	350	CZ		25		PR-1011	550	CZ	25
PR-1011	350	MET		25		PR-1011	550	MET	25
PR-1011	400			25		PR-1011	600		25
PR-1011	400	BR		25		PR-1011	600	BR	25
PR-1011	400	CZ		25		PR-1011	600	CZ	25
PR-1011	400	MET		25		PR-1011	600	MET	25

## Steel drawer systems



SPR-10150

SPR-10150	270		10		SPR-10150	400	MET	10
SPR-10150	270	MET	10		SPR-10150	450		10
SPR-10150	300		10		SPR-10150	450	MET	10
SPR-10150	300	MET	10		SPR-10150	500		10
SPR-10150	350		10		SPR-10150	500	MET	10
SPR-10150	350	MET	10		SPR-10150	550		10
SPR-10150	400		10		SPR-10150	550	MET	10

# Drawer slides and drawers

## Steel drawer systems















SPR-10118-MET



SPR-1086



SPR-1054

														
SPR-10118		270		10	SPR-1086		270		10	SPR-1054		270		10
SPR-10118		270	MET	10	SPR-1086		270	MET	10	SPR-1054		270	MET	10
SPR-10118		300		10	SPR-1086		300		10	SPR-1054		300		10
SPR-10118		300	MET	10	SPR-1086		300	MET	10	SPR-1054		300	MET	10
SPR-10118		350		10	SPR-1086		350		10	SPR-1054		350		10
SPR-10118		350	MET	10	SPR-1086		350	MET	10	SPR-1054		350	MET	10
SPR-10118		400		10	SPR-1086		400		10	SPR-1054		400		10
SPR-10118		400	MET	10	SPR-1086		400	MET	10	SPR-1054		400	MET	10
SPR-10118		450		10	SPR-1086		450		10	SPR-1054		450		10
SPR-10118		450	MET	10	SPR-1086		450	MET	10	SPR-1054		450	MET	10
SPR-10118		500		10	SPR-1086		500		10	SPR-1054		500		10
SPR-10118		500	MET	10	SPR-1086		500	MET	10	SPR-1054		500	MET	10
SPR-10118		550		10	SPR-1086		550		10	SPR-1054		550		10
SPR-10118		550	MET	10	SPR-1086		550	MET	10	SPR-1054		550	MET	10



Roller drawer slides

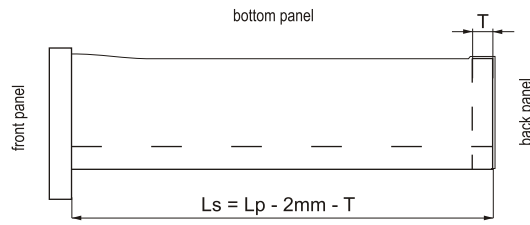
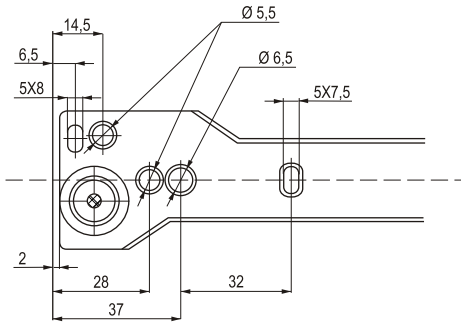

Lp - slide length  
 Ls - bottom length  
 T - back panel width

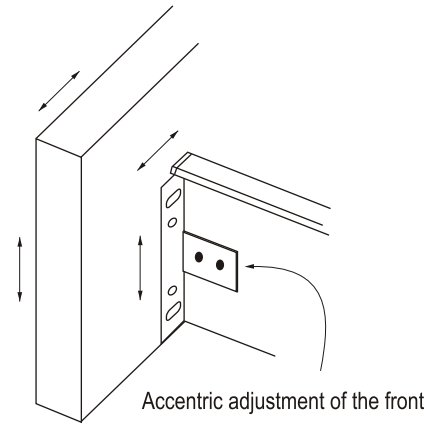
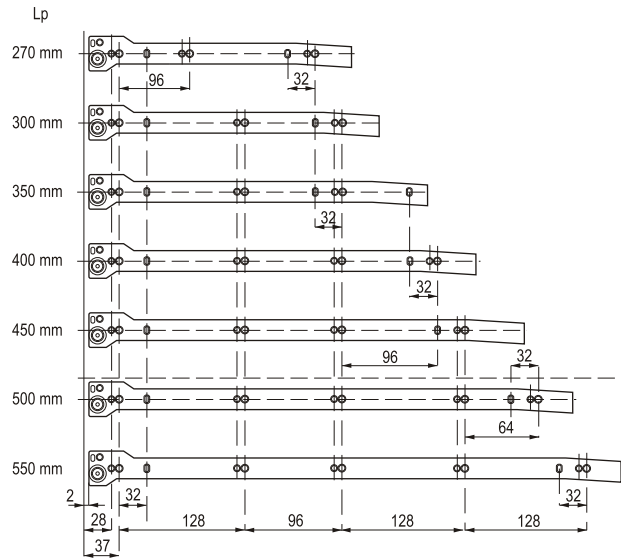

drawer's height available [mm]: 54; 86; 118; 150  
 self-closing feature with 60 mm closing range  
 parallel-closing feature-over the first 20 mm of the extension

max loading: 25 kg  
 height and side adjustment: up to 2 mm  
 standard colour: white, silver  
 packing: 10 sets/box



# Drawer slides and drawers

## Ball bearing drawer slides



PK01-310



PK02-264

PK01	310	100	100
PK02	182	100	100
PK02	264	100	100

## Relings for SPR



SPR-RELPD

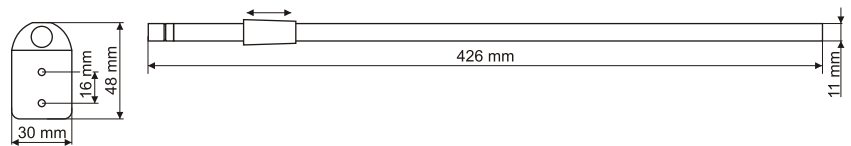

SPR-RELPD	300	MET	25
SPR-RELPD	300	R0040	25
SPR-RELPD	350	MET	25
SPR-RELPD	350	R0040	25
SPR-RELPD	400	MET	25
SPR-RELPD	400	R0040	25
SPR-RELPD	450	MET	25
SPR-RELPD	450	R0040	25
SPR-RELPD	500	MET	25
SPR-RELPD	500	R0040	25
SPR-RELPD	550	MET	25
SPR-RELPD	550	R0040	25



How to read the symbols

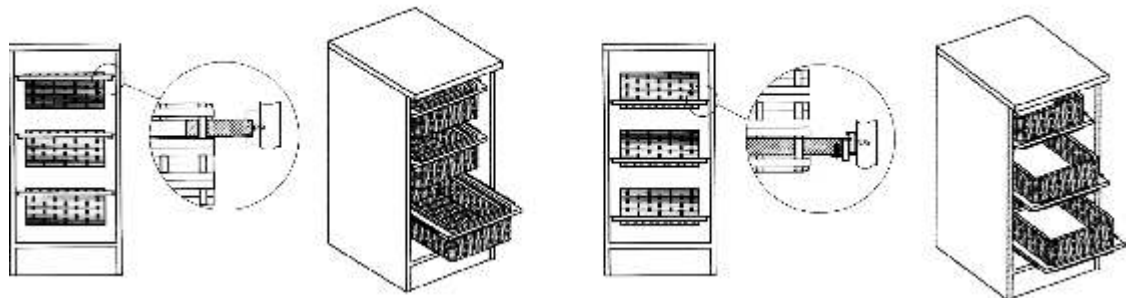
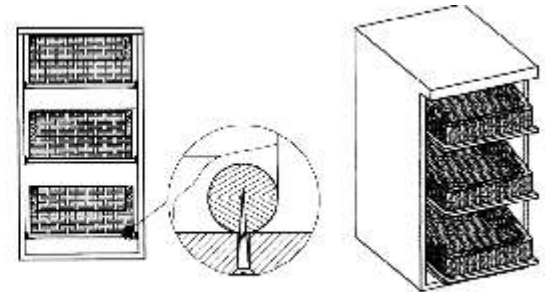
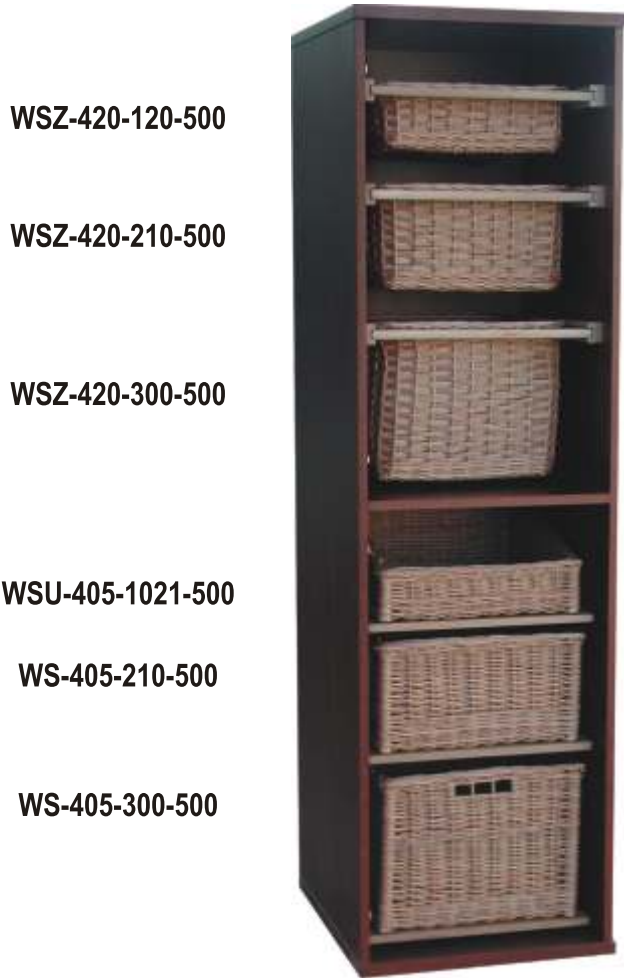
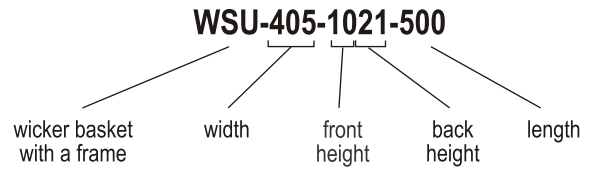
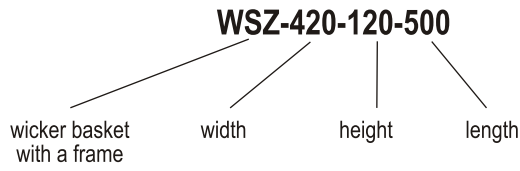

WS	260	450	480	1	WSZ	370	210	500	1
WS	340	230	470	1	WSZ	420	120	500	1
WS	400	400	140	1	WSZ	420	210	500	1
WS	405	210	500	1	WSZ	420	300	500	1
WS	405	300	500	1	WSZ	520	120	500	1
WS	600	600	140	1	WSZ	520	210	500	1
WSZ	320	120	500	1	WSZ	520	300	500	1
WSZ	320	210	500	1	WSZ	405	1021	500	1
WSZ	320	300	500	1					